

Braced Post Insulator Assembly B2901072T12085AA

1) H2 90 10 062 AX SS 024	[1]
2) S1 40 80 062 MA AL 040	[1]
3) Socket/Y-Clevis (SYC-56)	[1]
4) Turnbuckle (G-227-NBC-3/4x6C)	[1]
5) Shackle (ASH-55-BC)	[1]

ASSEMBLY DIMENSIONAL VALUES

Post Section Length (PSL)	71.9 in	1,826 mm
Suspension Section Length (SSL)	73.5 in	1,867 mm
Height of Assembly (H)	85.0 in	2,159 mm
Length of Brace (B)	97.7 in	2,482 mm
Upper Pole Connection Offset (A)*	2.0 in	51 mm
Angle Between Insulators (C)		57 Degrees
Dry Arc Distance	59.5 in	1,511 mm
Leakage Distance	170.0 in	4,318 mm

*This connection bracket to be supplied by customer

ASSEMBLY ELECTRICAL VALUES*

60 Hz Dry F.O. (Min. Withstand)	556 kV	(522) kV
60 Hz Wet F.O. (Min. Withstand)	513 kV	(409) kV
CIFO+ (Min. Withstand)	970 kV	(859) kV
CIFO- (Min. Withstand)	1,012 kV	(903) kV

*Values shown are based on minimum electricals for the assembly

ASSEMBLY MECHANICAL VALUES

Maximum Working Vertical Load	10,718 lbs	47.7 kN
-------------------------------	------------	---------

This drawing contains confidential information that is the property of MacLean Power, L.L.C. ("MacLean"). Use of MacLean's confidential information without MacLean's express written consent is strictly prohibited and may expose you to legal liability. If you believe that you received this material in error, please destroy it or return it to "MacLean Power, L.L.C., 7801 Park Place Rd., York, South Carolina 29745, USA."

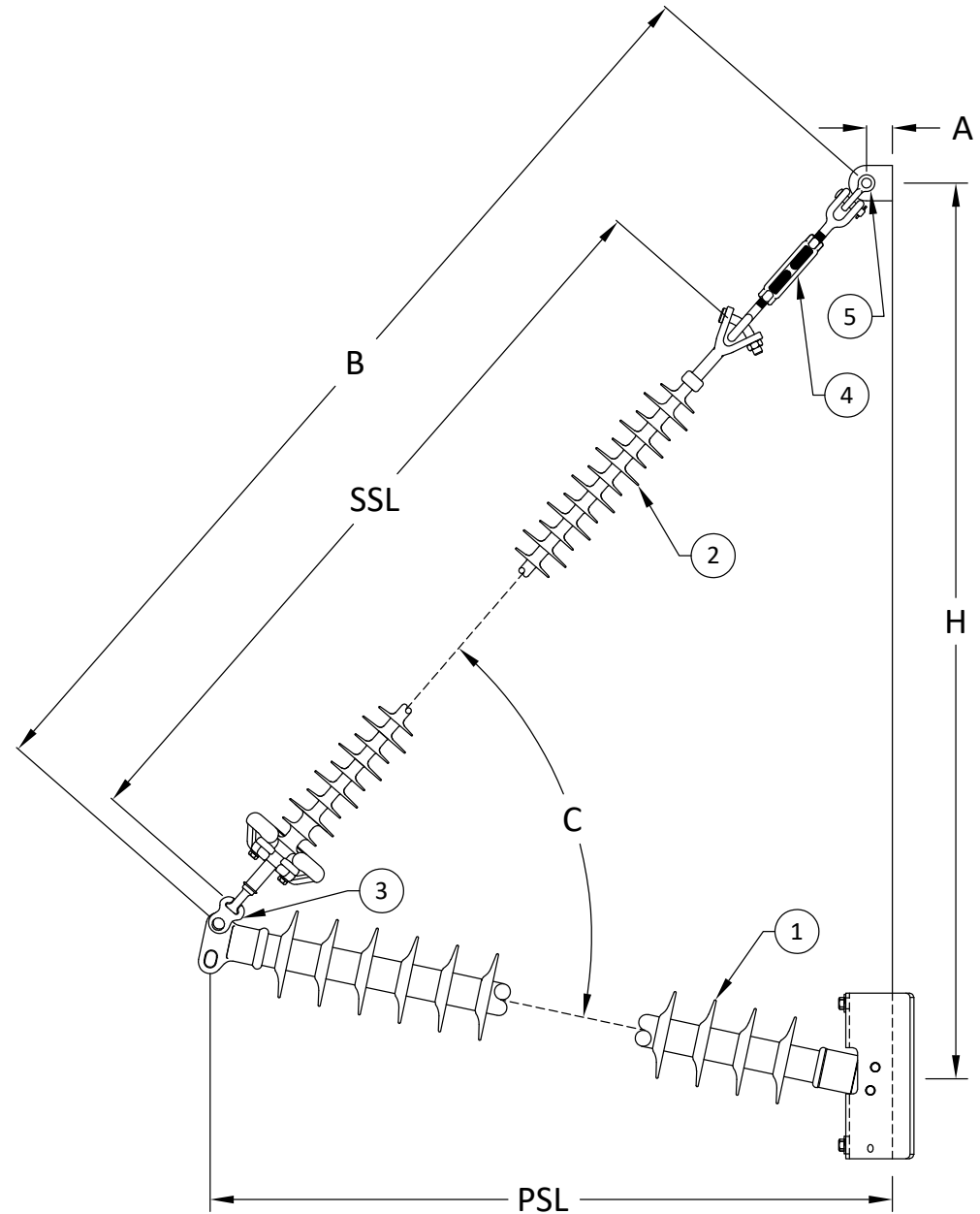

MPS Catalog Number:

H2 90 10 062 AX SS 024

Date:

04/11/2022

End Fittings

Tower End Fitting:

Gain / 12 deg / Steel

Line End Fitting:

Anchor / Ductile Iron
2 HL Drop Tongue / Galv. Ductile Iron

Material

Corona Ring (Tower):

None

Corona Ring (Line):

None

Corona Rings are recommended for applications of 230 kV and above

Mounting Angle:

12 deg

Number of Sheds:

24

Rod Diameter:

2.5 in

Weight Estimate:

81.8 lbs

37 kg

Dimensional Values

Section Length (L):

71.9 in 1,826 mm

Rubber Length (X):

62 in 1,575 mm

Shed spacing (S):

2.5 in 64 mm

Shed Projection (P):

2.4 in 61 mm

Dry Arc Distance:

64.9 in 1,648 mm

Leakage Distance:

170 in 4,318 mm

Electricals Values

60 Hz dry Flashover (Min. Withstand):

603 kV 566 kV

60 Hz Wet Flashover (Min. Withstand):

554 kV 444 kV

CIFO Positive (Min. Withstand):

1054 kV 932 kV

CIFO Negative (Min. Withstand):

1092 kV 978 kV

Mechanical Values

Max. Design Cant. Load (MDCL):

1,238 lbs 5.5 kN

Specified Cant. Load (SCL):

2,476 lbs 11.0 kN

Specified Tensile Load (STL):

15,000 lbs 66.7 kN

This drawing contains confidential information that is the property of MacLean Power, L.L.C. ("MacLean"). Use of MacLean's confidential information without MacLean's express written consent is strictly prohibited and may expose you to legal liability. If you believe that you received this material in error, please destroy it or return it to "MacLean Power, L.L.C., 7801 Park Place Rd., York, South Carolina 29745, USA."

Notes:

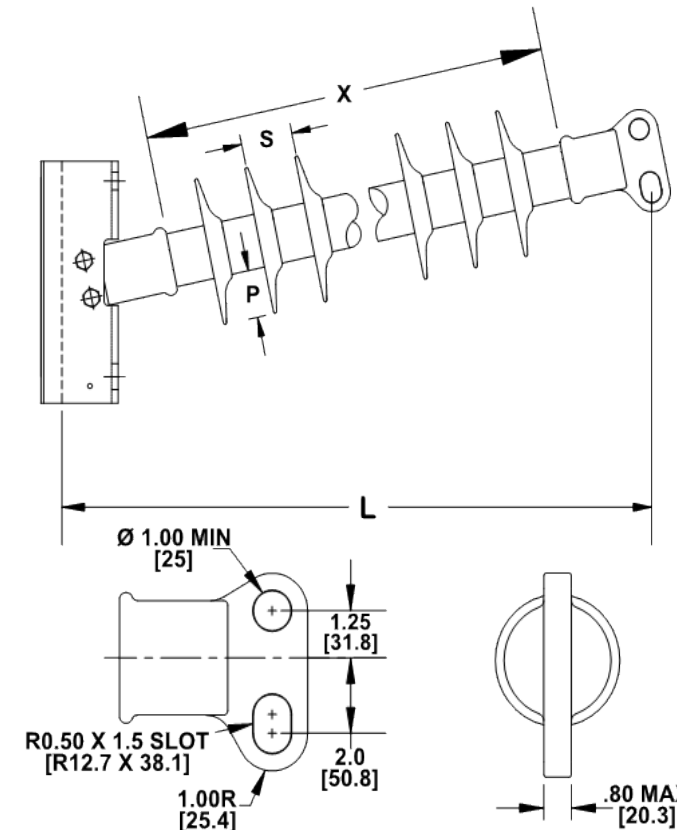
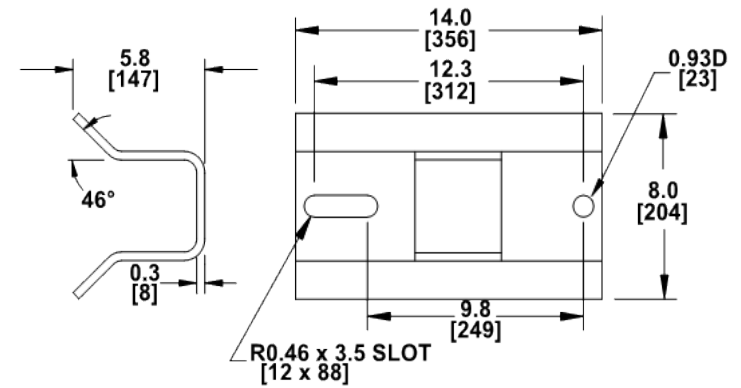

Dimension: inches [millimeters]

NOTE: Drawing not actual depiction of insulator appearance.

Silicone rubber sheath and sheds complies with applicable ANSI and IEC standards.

Prepared By: Stephen Lucci

MPS Catalog Number

S1 40 80 062 MA AL 040

Date: 04/11/2022

End Fittings

Tower End Fitting:

Y-Clevis / Forged Steel

Line End Fitting:

Ball / Forged Steel
/ (ANSI 52-5)

Material

Corona Ring (Line):

8" Corona Ring

Corona Rings are recommended for applications of 230 kV and above

Number of Sheds:

19 large 21 standard

Rod Diameter:

16 mm

Weight Estimate:

14.8 lbs 7 kg

Dimensional Values

Section Length (L):

73.5 in 1,867 mm

Rubber Length (X):

62 in 1,575 mm

Standard Shed Height (P1):

1.5 in 38 mm

Large Shed Height (P2):

2 in 51 mm

Projection Ration (S/P):

- 1.5

Shed Spacing (S):

3 in 76 mm

Dry Arc Distance:

61.1 in 1,552 mm

Leakage Distance:

180.7 in 4,590 mm

Electricals Values

60 Hz dry Flashover (Min. Withstand):

596 kV 546 kV

60 Hz Wet Flashover (Min. Withstand):

525 kV 457 kV

CIFO Positive (Min. Withstand):

1,009 kV 886 kV

CIFO Negative (Min. Withstand):

1,062 kV 938 kV

Mechanical Values

Specified Mech. Load (SML):

25,000 lbs 111.2 kN

Routine Test Load (RTL):

12,500 lbs 55.6 kN

This drawing contains confidential information that is the property of MacLean Power, L.L.C. ("MacLean"). Use of MacLean's confidential information without MacLean's express written consent is strictly prohibited and may expose you to legal liability. If you believe that you received this material in error, please destroy it or return it to "MacLean Power, L.L.C., 7801 Park Place Rd., York, South Carolina 29745, USA."

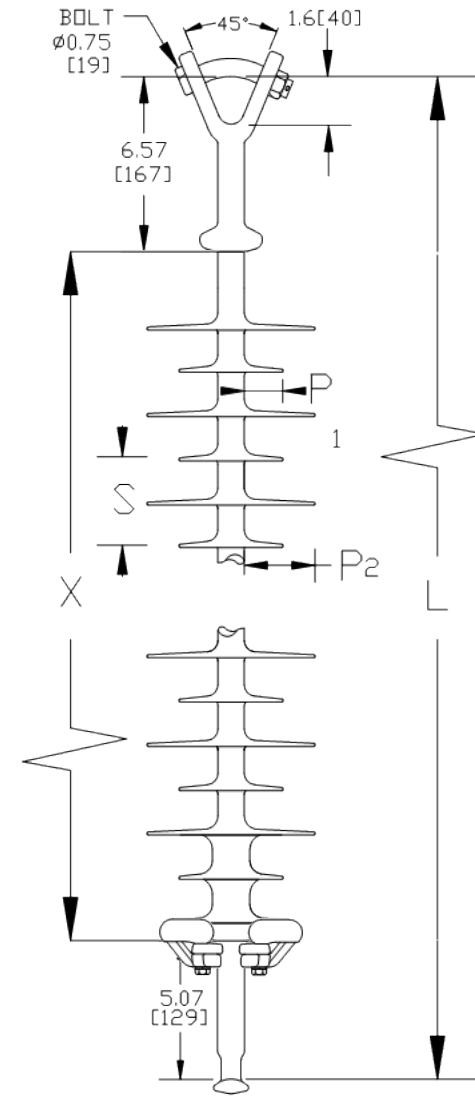

Dimension: inches [millimeters]

NOTE: Drawing not actual depiction of insulator appearance.

Silicone rubber sheath and sheds complies with applicable ANSI and IEC standards.

Notes:

Prepared By: Stephen Lucci



MacLean Power Systems

B2901072T12085AA Ultimate Combined Load Curve

Factor of Safety = 1

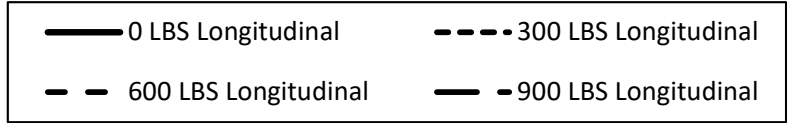

Assumptions:
-Loading sequence is Longitudinal, Vertical, Transverse
-Factor of Safety applied to entire system
-Negligible downward tip deflection
-Static moduli values
-Confidence level of 95%

