

REVISIONS				
NO.	DATE	DESCRIPTION	BY	CHKD
1	05/21/20	UPDATED STAR WASHER VIEW	EDB	
2	11/18/21	CHANGED PAINT OPTION TO VEIL	EDB	

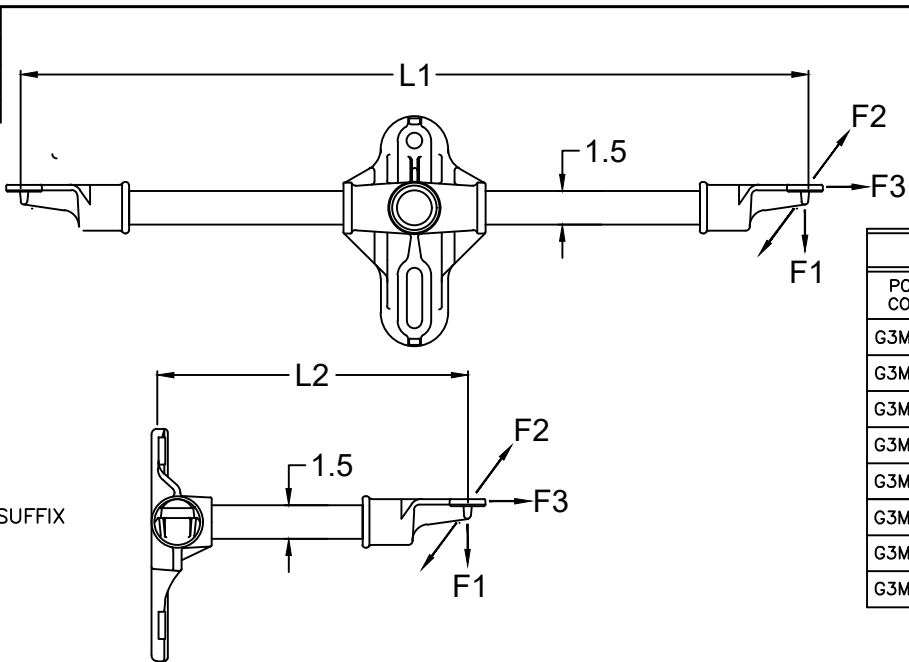

CATALOG NUMBER		LENGTHS (IN)		ULTIMATE MECHANICAL STRENGTHS (LBS)		
POLYURETHANE COATED SERIES	SILICONE RUBBER COATED SERIES	L1	L2	F1 VERT.	F2 LONG.	F3 TRANS.
G3MA013613DD	G3MA013613DDSC	36	13	1200	900	10000
G3MA013618DD	G3MA013618DDSC	36	18	1200	900	10000
G3MA014013DD	G3MA014013DDSC	40	13	1100	800	10000
G3MA014017DD	G3MA014017DDSC	40	17	1100	800	10000
G3MA014813DD	G3MA014813DDSC	48	13	900	700	10000
G3MA014816DD	G3MA014816DDSC	48	16	900	700	10000
G3MA014818DD	G3MA014818DDSC	48	18	900	700	10000
G3MA014824DD	G3MA014824DDSC	48	24	900	700	10000

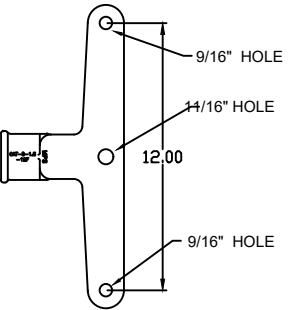

END FITTING VIEW -DD, -DDSC SUFFIX
->CAT-0-1.5-12FC

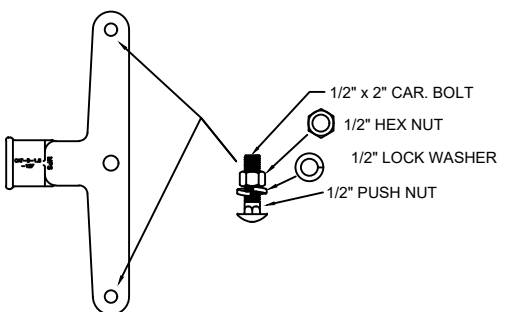

END FITTING VIEW -DDB, -DDBC SUFFIX
->CAT-0-1.5-12F-H (OPTIONAL)
W/ HARDWARE

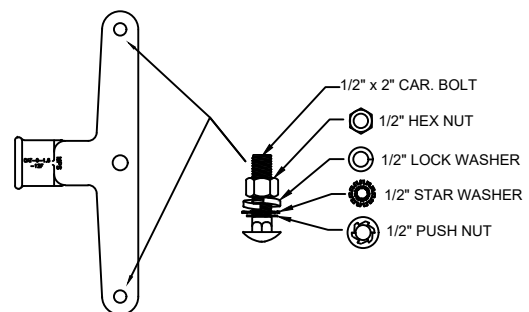

END FITTING VIEW -DDW, -DDWC SUFFIX
->CAT-0-1.5-12FWH (OPTIONAL)
W/ HARDWARE

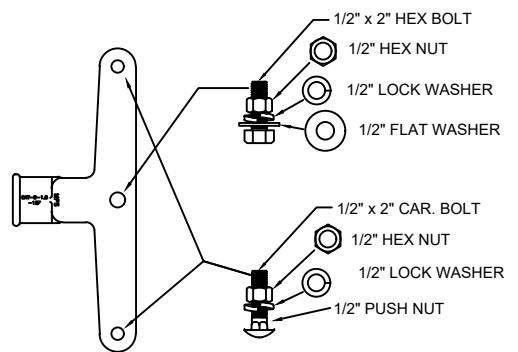

END FITTING VIEW -DDX SUFFIX
->CAT-0-1.5-12FHX (OPTIONAL)
W/ HARDWARE

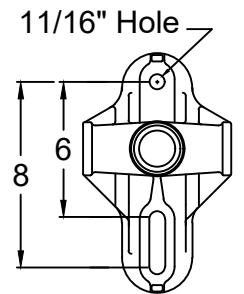

BASE VIEW

NOTES:

- 1.0 MATERIAL
 - 1.1 BASE - ALUMINUM, A356-T6
 - 1.2 END FITTING - DUCTILE IRON GRADE 654512
 - 1.3 ROD - FIBERGLASS
- 2.0 FINISH
 - 2.1 BASE - NONE
 - 2.2 END FITTING - HOT DIP GALVANIZED PER ASTM-A-153
 - 2.3 ROD - ULTRAVIOLET PROTECTIVE VEIL COATING, GRAY (OPTIONAL) - VULCANIZED SILICONE RUBBER, GRAY
- 3.0 DIMENSIONS IN INCHES

This information is confidential and is the property of Maclean Power Systems. It may not be made public or reproduced except that the Customer may make copies for use solely in installation, maintenance, and operation of products supplied by Maclean Power Systems.

 MACLEAN POWER SYSTEMS A Maclean-fogg Company	
G3MA01-"L1L2"-DD SERIES TRIPLE PHASE, ZERO DEGREE, DOUBLE POSITION BRACKET	
DATE: 6-08-12	SCALE: 1:1
NO. CEB-3992	R/2
DRN: MYL	SH: DF

ENG. REF.