

REVISIONS					
NO.	DATE	DESCRIPTION	BY	CHKD	
1	05/15/14	ADDED G3MA026030DD SIZE.	WCL	WCL	
2	09/16/15	ADDED G3MA024816DD SIZE.	WCL	WCL	
3	12/08/15	ADDED "DTB" & "DTBC" OPTIONS.	WCL	WCL	
4	04/25/16	DDBS & DDSC WERE DTB & DTBC.	WCL	WCL	
5	05/21/20	UPDATED STAR WASHER VIEW	EDB		
6	11/18/21	CHANGED PAINT OPTION TO VEIL	EDB		

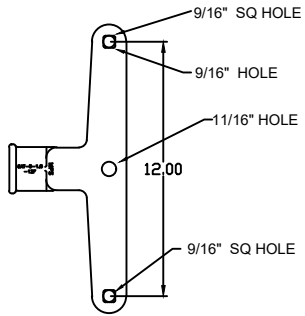

END FITTING VIEW -DD, -DDSC SUFFIX  
->CAT-0-1.5-12FC

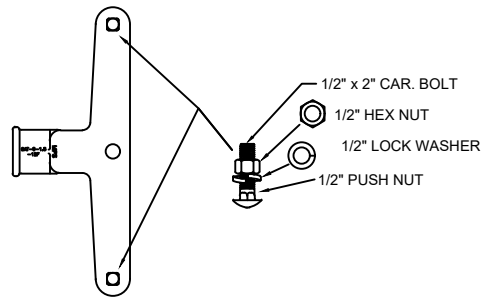

END FITTING VIEW -DDB, -DDBC SUFFIX  
->CAT-0-1.5-12F-H (OPTIONAL)  
W/ HARDWARE

NOTES:

- 1.0 MATERIAL
  - 1.1 BASE - ALUMINUM, A356-T6
  - 1.2 END FITTING - DUCTILE IRON GRADE 654512
  - 1.3 ROD - FIBERGLASS
- 2.0 FINISH
  - 2.1 BASE - NONE
  - 2.2 END FITTING - HOT DIP GALVANIZED PER ASTM-A-153
  - 2.3 ROD - ULTRAVIOLET PROTECTIVE VEIL COATING, GRAY (OPTIONAL) - VULCANIZED SILICONE RUBBER, GRAY
- 3.0 DIMENSIONS IN INCHES

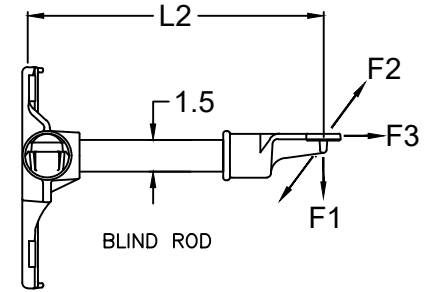
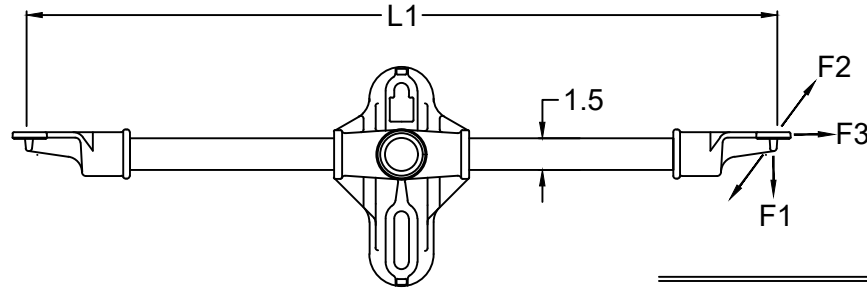

11/16" Keyhole

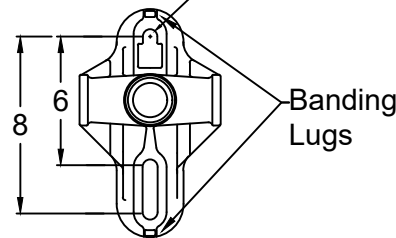

BASE VIEW

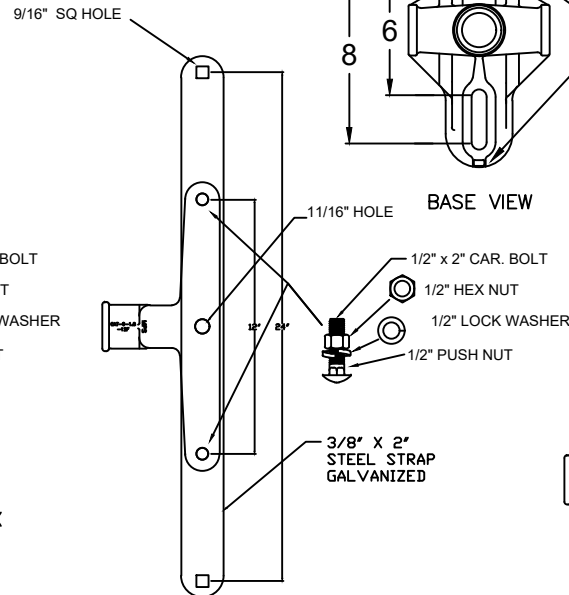

END FITTING VIEW -DDBS, -DDBSC SUFFIX  
->CAT-0-1.5-12F-S24 (OPTIONAL)  
W/ 3/8" X 2" X 25.5" STEEL STRAP

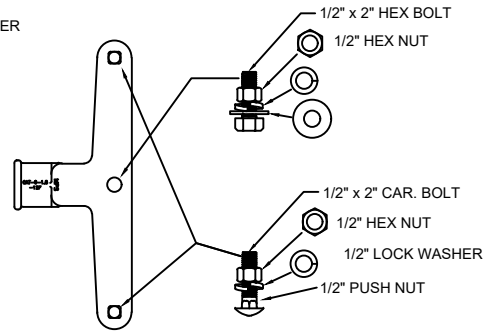

END FITTING VIEW -DDX SUFFIX  
->CAT-0-1.5-12FHX (OPTIONAL)  
W/ HARDWARE

CATALOG NUMBER		LENGTHS (IN)		ULTIMATE MECHANICAL STRENGTHS (LBS)		
POLYURETHANE COATED SERIES	SILICONE RUBBER COATED SERIES	L1	L2	F1 VERT.	F2 LONG.	F3 TRANS.
G3MA023613DD	G3MA023613DDSC	36	13	1200	900	10000
G3MA023618DD	G3MA023618DDSC	36	18	1200	900	10000
G3MA024221DD	G3MA024221DDSC	42	21	1025	800	10000
G3MA024813DD	G3MA024813DDSC	48	13	900	700	10000
G3MA024816DD	G3MA024816DDSC	48	16	900	700	10000
G3MA024818DD	G3MA024818DDSC	48	18	900	700	10000
G3MA024824DD	G3MA024824DDSC	48	24	900	700	10000
G3MA026030DD	G3MA026030DDSC	60	30	700	500	10000

NOTE: "BX" SUFFIX INDICATES BOXED. EX. G3MA024813DDBX.

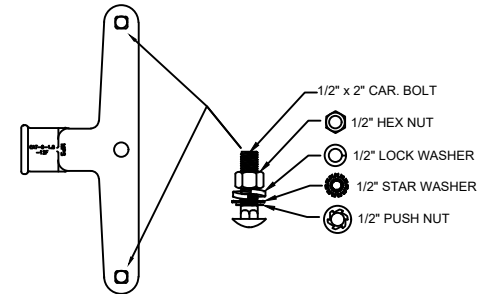

END FITTING VIEW -DDW, -DDWC SUFFIX  
->CAT-0-1.5-12FWH (OPTIONAL)  
W/ HARDWARE



**MACLEAN POWER SYSTEMS**  
A Maclean-fogg Company

G3MA02-"L1L2"-DD SERIES  
TRIPLE PHASE, ZERO DEGREE,  
DOUBLE POSITION BRACKET

DATE: 6-08-12	SCALE: 1:1	NO.	CEB-3993	R/6	SH/DF
DRN: MYL	CD: APR	BY: BR			

This information is confidential and is the property of Maclean Power Systems. It may not be made public or reproduced except that the Customer may make copies for use solely in installation, maintenance, and operation of products supplied by Maclean Power Systems.