



MacLean Power Systems
 7801 Park Place Rd., York, SC 29745
 USA (803) 628-2100

MPS Catalog Number

H0 40 20 004 MX SS 002

Revision: B

Date 3/3/2021

End Fittings

Tower End Fitting:

3/4"-10 Round Base (Galv. Duct. Iron)

Line End Fitting:

Trunnion (Aluminum)

Material

Number of Sheds: 2

Rod Diameter: 1-1/2"

Weight Estimate: 6.3 lbs 2.9 kg

Dimensional Values

Section Length (L):	12.0 in	306 mm
Rubber Length (X):	4.0 in	101 mm
Shed Height (P):	2.3 in	58 mm
Shed Diameter (B):	6.5 in	165 mm
Shed Spacing (S):	2.0 in	51 mm
Dry Arc Distance:	6.2 in	158 mm
Leakage Distance:	12.2 in	310 mm

Electricals Values

60 Hz dry Flashover:	88 kV	Min. Withstand	73 kV
60 Hz Wet Flashover:	59 kV	Min. Withstand	41 kV
Positive CIFO:	136 kV	Min. Withstand	108 kV
Negative CIFO:	163 kV	Min. Withstand	139 kV

Mechanical Values

Max. Design Cant. Load (MDCL):	1,350 lbs	6.0 kN
Specified Cant. Load (SCL):	2,800 lbs	12.5 kN
Specified Tensile Load (STL):	5,000 lbs	22.2 kN

This drawing contains confidential information that is the property of MacLean Power, L.L.C. ("MacLean"). Use of MacLean's confidential information without MacLean's express written consent is strictly prohibited and may expose you to legal liability. If you believe that you received this material in error, please destroy it or return it to "MacLean Power, L.L.C., 7801 Park Place Rd., York, South Carolina 29745, USA."

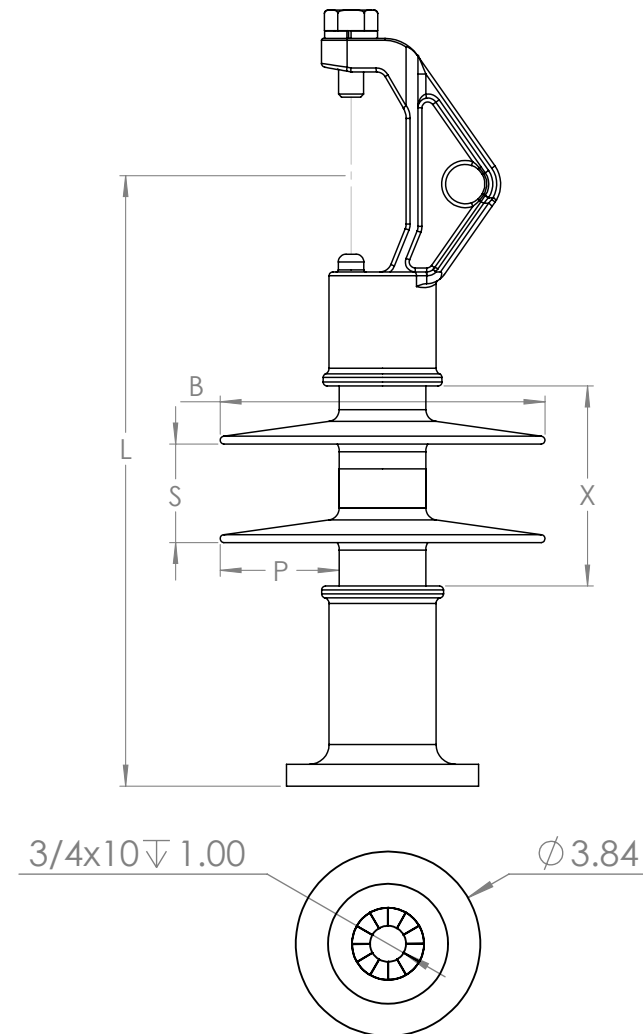

Dimension: inches [millimeters]

Insulator assembly complies with ANSI C.29.18 and CSA C411.6 Standards

NOTE: Drawing not actual depiction of insulator appearance