

MPS Catalog Number:

Date:

H1 90 10 034 AX SS 013

05/20/2021

End Fittings

Tower End Fitting:

Gain / 12 deg / Steel

Line End Fitting:

Anchor / Ductile Iron
2 HL Drop Tongue / Ductile Iron

Material

Corona Ring (Tower):

None

Corona Ring (Line):

None

Corona Rings are recommended for applications of 230 kV and above

Mounting Angle:

12 deg

Number of Sheds:

13

Rod Diameter:

2 in

Weight Estimate:

52.2 lbs

24 kg

Dimensional Values

Section Length (L):

43.7 in 1,110 mm

Rubber Length (X):

34 in 864 mm

Shed spacing (S):

2.5 in 64 mm

Shed Projection (P):

2.7 in 68 mm

Dry Arc Distance:

37 in 940 mm

Leakage Distance:

99.7 in 2,532 mm

Electricals Values

60 Hz dry Flashover (Min. Withstand):

357 kV 336 kV

60 Hz Wet Flashover (Min. Withstand):

331 kV 258 kV

CIFO Positive (Min. Withstand):

614 kV 549 kV

CIFO Negative (Min. Withstand):

701 kV 586 kV

Mechanical Values

Max. Design Cant. Load (MDCL):

1,027 lbs 4.6 kN

Specified Cant. Load (SCL):

2,054 lbs 9.1 kN

Specified Tensile Load (STL):

7,000 lbs 31.1 kN

This drawing contains confidential information that is the property of MacLean Power, L.L.C. ("MacLean"). Use of MacLean's confidential information without MacLean's express written consent is strictly prohibited and may expose you to legal liability. If you believe that you received this material in error, please destroy it or return it to "MacLean Power, L.L.C., 7801 Park Place Rd., York, South Carolina 29745, USA."

Notes:

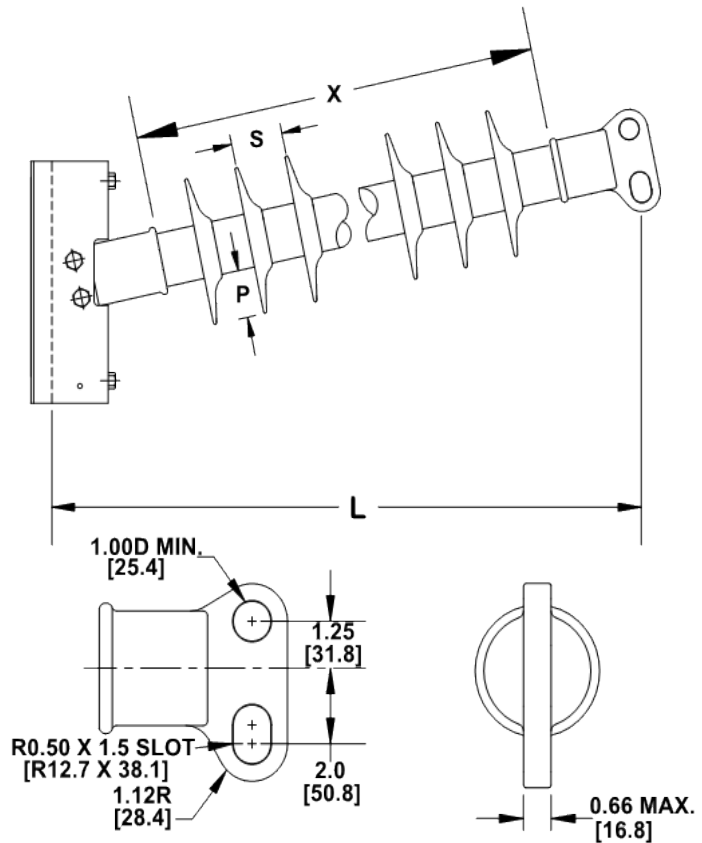
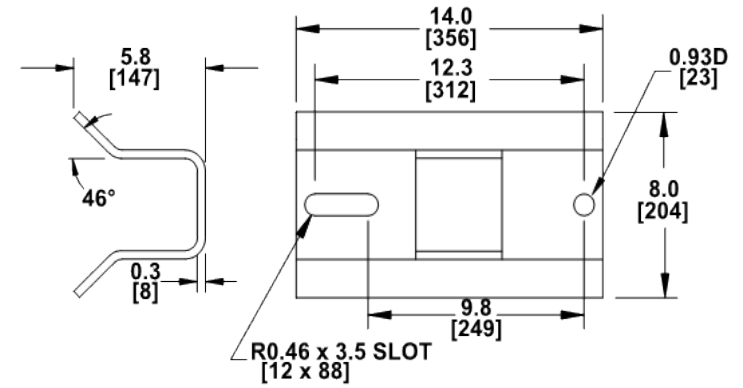

Dimension: inches [millimeters]

NOTE: Drawing not actual depiction of insulator appearance.

Silicone rubber sheath and sheds complies with applicable ANSI and IEC standards.

Prepared By: Laurel Wallace