

MPS Catalog Number:

Date:

H3 90 10 046 BX SS 022

05/20/2021

End Fittings

Tower End Fitting:

Gain/12"-14" Hole Spacing

Anchor / Galv. Ductile Iron

Line End Fitting:

2 HL Drop Tongue / Galv. Ductile Iron

Material

Corona Ring (Tower):

None

Corona Ring (Line):

None

Corona Rings are recommended for applications of 230 kV and above

Mounting Angle:

17 deg

Number of Sheds:

22

Rod Diameter:

3 in

Weight Estimate:

105.1 lbs

48 kg

Dimensional Values

Section Length (L):

59.4 in 1,509 mm

Rubber Length (X):

46 in 1,168 mm

Shed spacing (S):

2 in 51 mm

Shed Projection (P):

2.7 in 68 mm

Dry Arc Distance:

49 in 1,245 mm

Leakage Distance:

153.1 in 3,889 mm

Electricals Values

60 Hz dry Flashover (Min. Withstand):

464 kV 436 kV

60 Hz Wet Flashover (Min. Withstand):

430 kV 340 kV

CIFO Positive (Min. Withstand):

804 kV 716 kV

CIFO Negative (Min. Withstand):

857 kV 757 kV

Mechanical Values

Max. Design Cant. Load (MDCL):

2,723 lbs 12.1 kN

Specified Cant. Load (SCL):

5,446 lbs 24.2 kN

Specified Tensile Load (STL):

20,000 lbs 89.0 kN

This drawing contains confidential information that is the property of MacLean Power, L.L.C. ("MacLean"). Use of MacLean's confidential information without MacLean's express written consent is strictly prohibited and may expose you to legal liability. If you believe that you received this material in error, please destroy it or return it to "MacLean Power, L.L.C., 7801 Park Place Rd., York, South Carolina 29745, USA."

Notes:

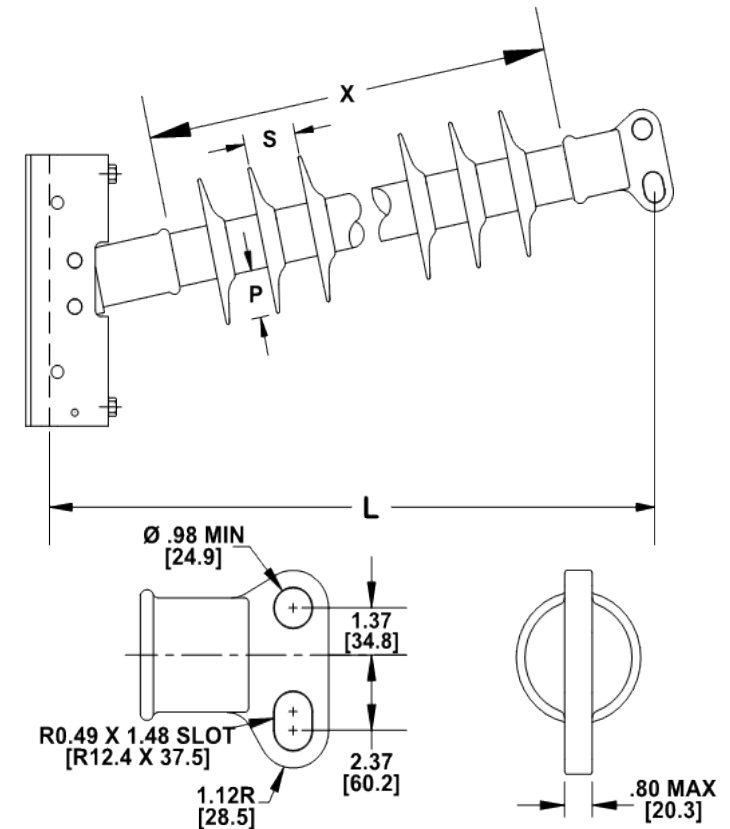
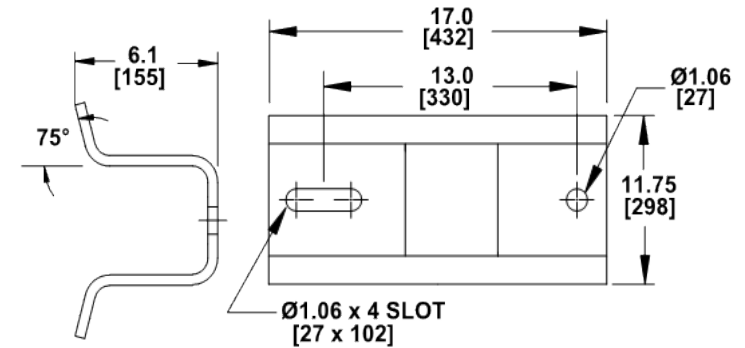

Dimension: inches [millimeters]

NOTE: Drawing not actual depiction of insulator appearance.

Silicone rubber sheath and sheds complies with applicable ANSI and IEC standards.

Prepared By: Laurel Wallace