

MPS Catalog Number:

Date:

H3 90 10 052 AX SS 020

05/20/2021

End Fittings

Tower End Fitting:

Gain/12"-14" Hole Spacing

Anchor / Galv. Ductile Iron

Line End Fitting:

2 HL Drop Tongue / Galv. Ductile Iron

Material

Corona Ring (Tower):

None

Corona Ring (Line):

None

Corona Rings are recommended for applications of 230 kV and above

Mounting Angle:

17 deg

Number of Sheds:

20

Rod Diameter:

3 in

Weight Estimate:

107.2 lbs

49 kg

Dimensional Values

Section Length (L):

65.2 in 1,656 mm

Rubber Length (X):

52 in 1,321 mm

Shed spacing (S):

2.5 in 64 mm

Shed Projection (P):

2.7 in 68 mm

Dry Arc Distance:

55 in 1,397 mm

Leakage Distance:

149.3 in 3,792 mm

Electricals Values

60 Hz dry Flashover (Min. Withstand):

517 kV 485 kV

60 Hz Wet Flashover (Min. Withstand):

477 kV 379 kV

CIFO Positive (Min. Withstand):

899 kV 798 kV

CIFO Negative (Min. Withstand):

944 kV 841 kV

Mechanical Values

Max. Design Cant. Load (MDCL):

2,433 lbs 10.8 kN

Specified Cant. Load (SCL):

4,866 lbs 21.6 kN

Specified Tensile Load (STL):

20,000 lbs 89.0 kN

This drawing contains confidential information that is the property of MacLean Power, L.L.C. ("MacLean"). Use of MacLean's confidential information without MacLean's express written consent is strictly prohibited and may expose you to legal liability. If you believe that you received this material in error, please destroy it or return it to "MacLean Power, L.L.C., 7801 Park Place Rd., York, South Carolina 29745, USA."

Notes:

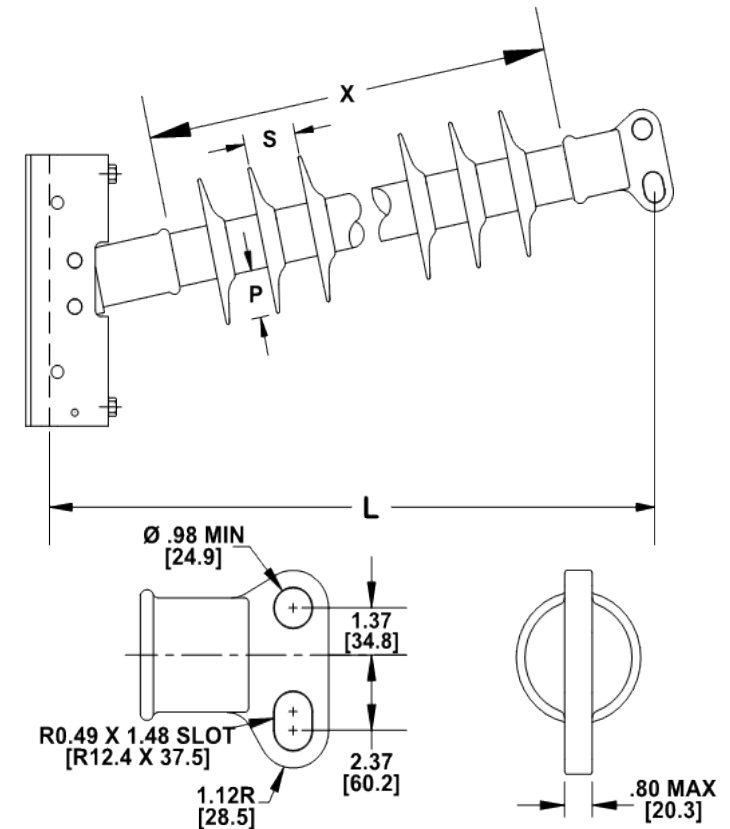
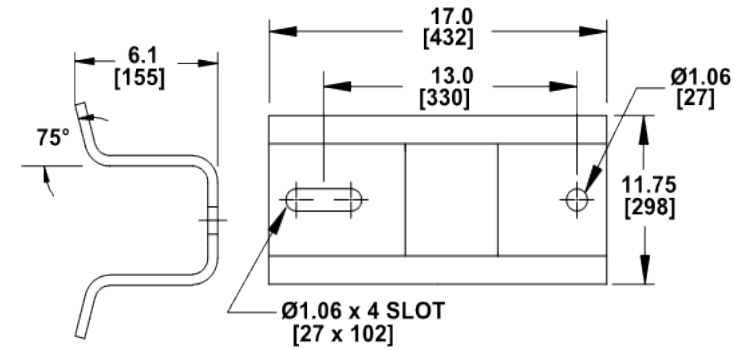

Dimension: inches [millimeters]

NOTE: Drawing not actual depiction of insulator appearance.

Silicone rubber sheath and sheds complies with applicable ANSI and IEC standards.

Prepared By: Laurel Wallace