

A | B | C | D | E | F

PAPER SIZE		DRAWING NUMBER	
B SIZE		GD-J8899	
REV	REVISION DATE	ECO	
A	08-05-09	9609	
B	08-13-12	10690	

ITEM	QUANTITY	DESCRIPTION
1	1	BOLT DIAMETER 3/4
2	4	NUT SQUARE 3/4

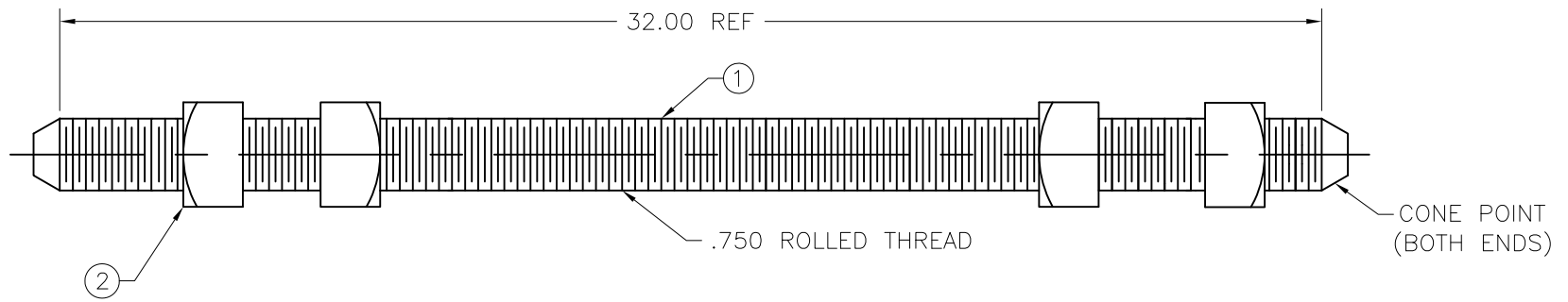

NOTES:

1. MATERIAL: HOT ROLLED CARBON STEEL
2. ALL DIMENSIONS ARE REFERENCE AND ARE IN INCHES.
3. ALL ITEMS ARE HOT DIP GALVANIZED PER ASTM A-153.

PART NO. F614981

This drawing contains confidential information that is the property of MacLean Power, L.L.C. ("MacLean"). Use of MacLean's confidential information without MacLean's express written consent is strictly prohibited and may expose you to legal liability. If you believe that you received this material in error, please destroy it or return it to "MacLean Power, L.L.C., 11411 Addison, Franklin Park, Illinois 60131, USA."

DRAWING-COMPUTER LOCATION

TOLERANCES UNLESS SPECIFIED	
inch	
0.XX	— — —
0.XXX	— — —
ANGLE	— — —



**MACLEAN
POWER
SYSTEMS**
11411 ADDISON STREET
FRANKLIN PARK, IL 60131

DRAWN BY	ENGINEER	CHECKER	CATALOG #	SCALE	DESIGN DATE
RC	DEK	FJS	J8899	NTS	08-05-09
DRAWING TITLE / DESCRIPTION					DRAWING NUMBER
BOLT DOUBLE ARMING 3/4					GD-J8899